

Application Note

How to use the TOMBAK as a Pulse-Picker

Multiboard Series

TOMBAK : Synchronization electronic board

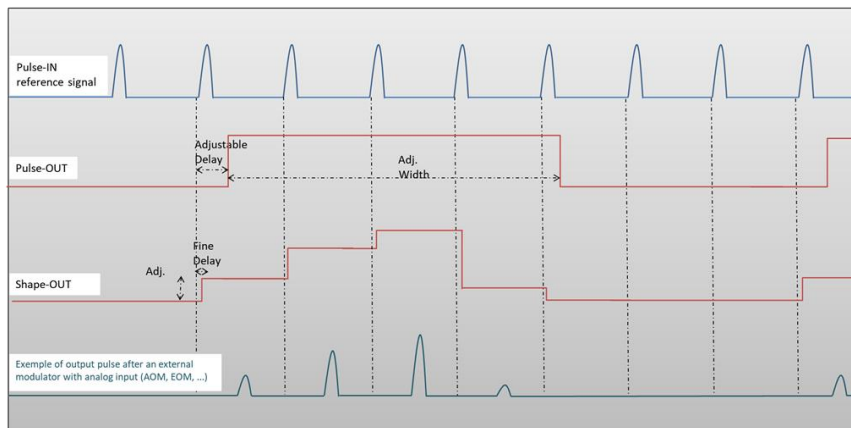
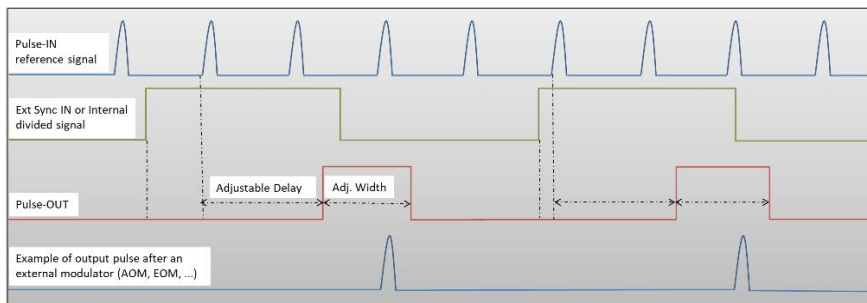
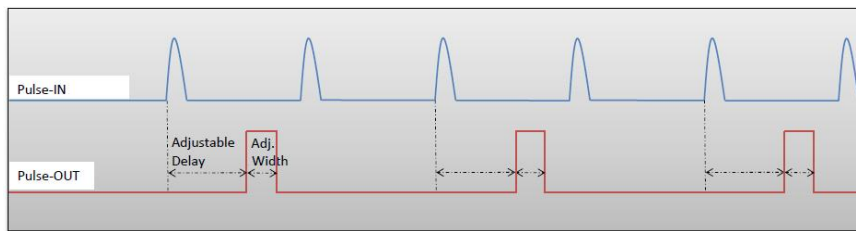

How to use the TOMBAK as a Pulse Picker

Pre-requirement: Before using the TOMBAK board, make sure you followed all the instructions mentioned in the Operating Manual

1. Introduction / Overview

When someone wants to generate a pulse (open a time domain door) at a low repetition rate (for example Hz/kHz range) which must be synchronized with a high frequency signal/clock (for example 100MHz range), There is two solutions :

1. The most immediate is to divide the clock signal frequency. Using the Tombak for that is described in the first part of this document. **See page 3**
2. When the low frequency pulse/door must also be synchronized with a low frequency external or internal signal (in other word, when we want a low repetition rate pulse at a repetition rate of a low repetition rate trigger BUT synchronized with a high frequency clock), the solution is to use the PICK mode of the Tombak. Note that in this last case, if the low frequency trigger is not synchronized with the high frequency clock, there will be a unavoidable Jitter which value is $1/\text{clock frequency}$. **See page 8**

In both case above, the TOMBAK opens a door with adjustable delays and adjustable width.

Another using case is relevant when multiple pulses (Burst) are isolated (pulse picked) and one wants to adjust the power intensity of every pulse independently :

3. When used as an AWG, TOMBAK can generate special pulse waveforms with up to 4000 steps of down to 5 nanosecond. TOMBAK, can also be used to generate Burst pulses with non-repetitive frequency and/or with adjustable amplitude. The Shape-OUT SMA connector can be connected to the analog input of a dedicated external modulation instrument like an AOM (acousto-optic modulator), an EOM (electro-optic modulator), a SOA, a scanning system or a laser...It is thus possible to create some Burst with nearly any shape and number of pulses up to 4000 pulses per Burst. This is particularly interesting within a mode locked laser with MOPA configuration when someone wants to generate some burst from the oscillator part. Generating special exponential Burst shape can pre-compensate the deformation of the burst through the amplifiers and help maintaining a nice shape at the output of the MOPA laser. **See page 13**

Mode 1 : Pulse Picking using the Divider mode

1 Timing Diagram

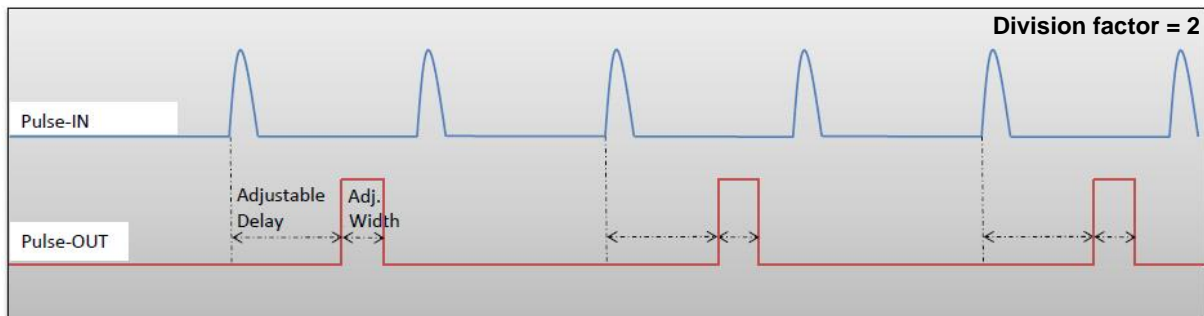

Figure 1 : Frequency divided, delayed and pulse width adjusted signal from input to output

2. Synoptic

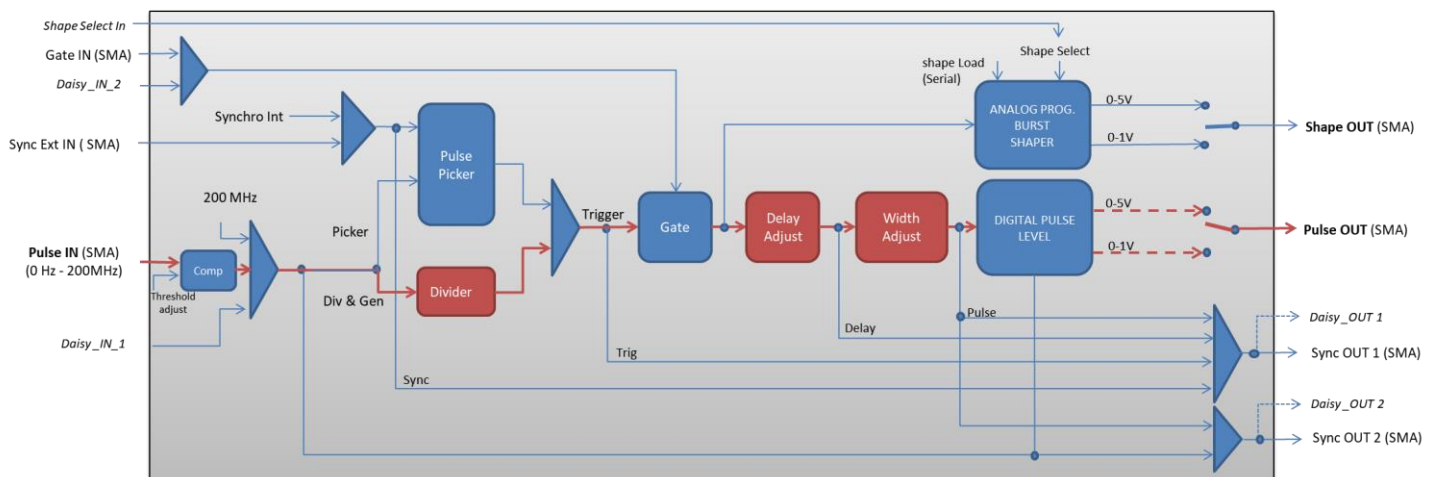
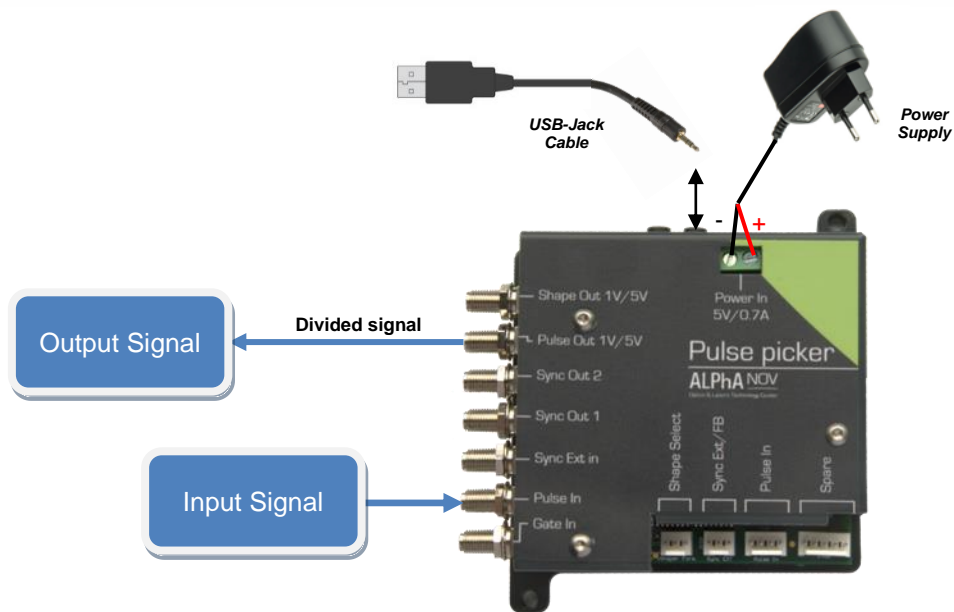

Figure 2 : Main firmware features used in frequency divider mode

3. Cabling

1. Plug the USB-Jack cable in the "USB In" connector
2. Plug the signal generator (i.e. the signal you want to delay) in the "Pulse In" SMA connector
3. The software adjustable delay and pulse width signal will output on the "Pulse Out" SMA connector
4. Finally, plug the power supply to the "Power In" connector to power on the board



4. Software configuration

Launch the ALPhANOV Control Software and click on *Connect* to start the TOMBAK hardware detection. The software automatically detects the TOMBAK board.

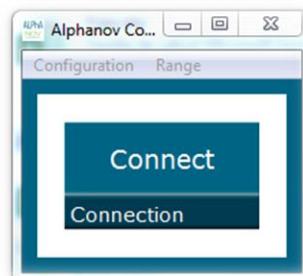

A window will appear for each TOMBAK connected to the computer.

The main configuration windows must be configured as follow :

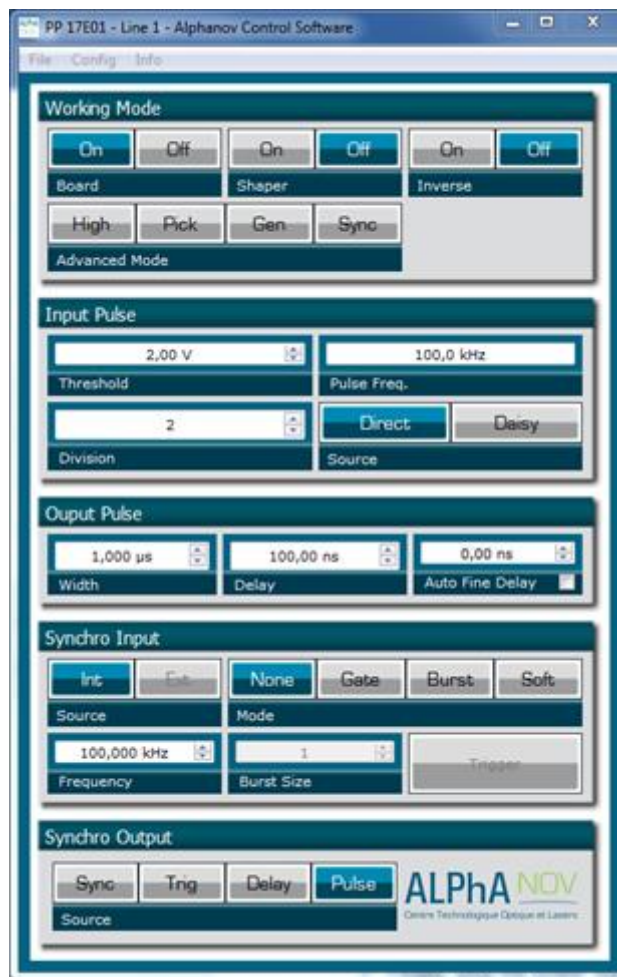

- Working Mode window :
 - Set the **Board On**
 - Set the **Shaper Off**
 - Set the **Inverse Off** unless you need to invert the output signal
 - Unset all **Advanced Mode**

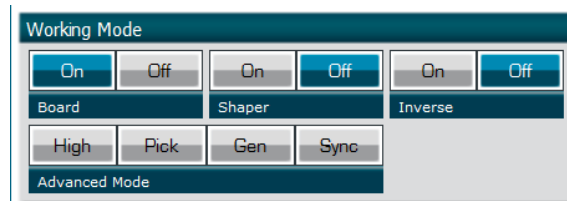

- Input pulse window :
 - Configure the **Threshold** voltage so that the input **pulse frequency** is detected and equal to your pulse generator system
 - Set the **Division** factor **according to your application**
 - Set the input pulse **Source** to **Direct**



- Output Pulse window :
 - Choose the output **delay** value
 - Choose the output **pulse width**
 - **Auto Fine Delay** may be let in auto mode

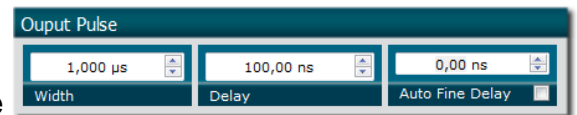

- Synchro input windows :
 - Source : not used in this mode
 - Mode : None
 - Frequency : not used in this mode
 - Burst size : not used in this mode

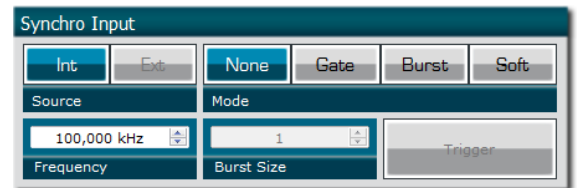

- Synchro output window (default settings) :
 - Source : Pulse

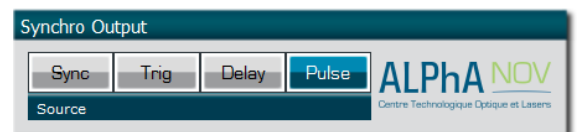

Don't forget to save the settings by clicking on the "Save" button in the bar menu.

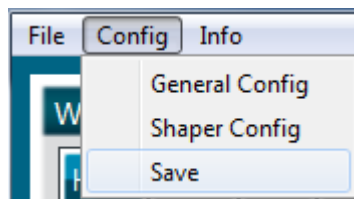

5. Main features

Frequency divider factor	[1 – 10 ⁹]
Adjustable pulse width <ul style="list-style-type: none">▪ resolution (for pulse width [5ns – 510ns])▪ resolution (for pulse width [511ns – 2⁶²ns])	[5ns – >>1000s] 2ns 5ns
Adjustable pulse delay <ul style="list-style-type: none">▪ resolution	[70ns – >>1000s] 10ps
Jitter <ul style="list-style-type: none">▪ for delay < 570ns & pulse width < 510ns▪ for any other delay & pulse width	<200 ps RMS 1.5 ns RMS
Input PulseIn voltage	30 mV – 3,3V
Input maximum frequency	200 MHz
Output Voltage	1 / 3,3 / 5 Volts (hardware setup)
Output maximum frequency	20 MHz

Mode 2 : Pulse Picking using the Pick mode

1. Timing Diagram

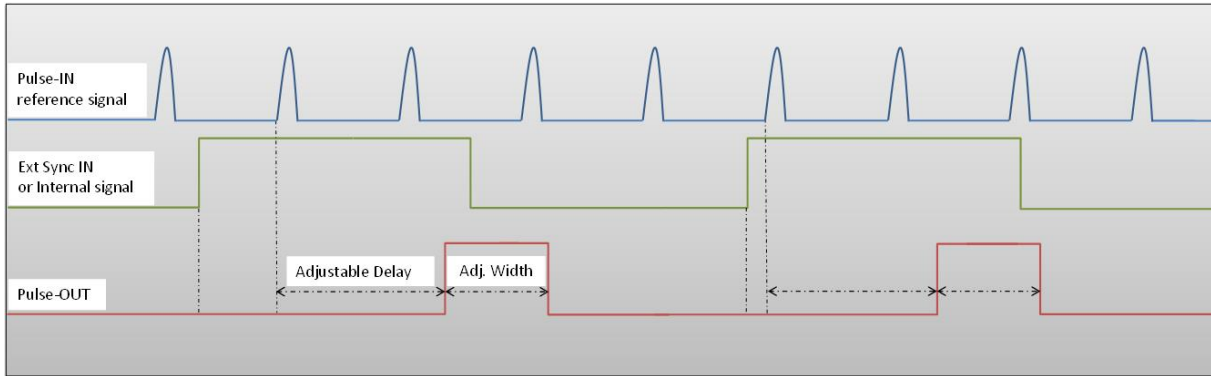

Figure 3 : External or internal signal synchronized with Pulse-In signal.

2. Synoptic

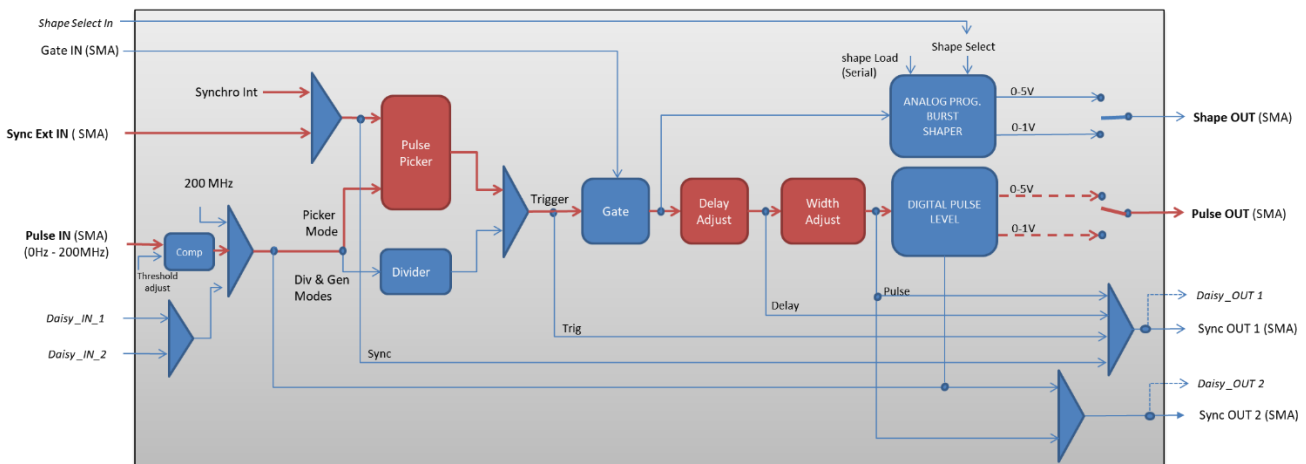
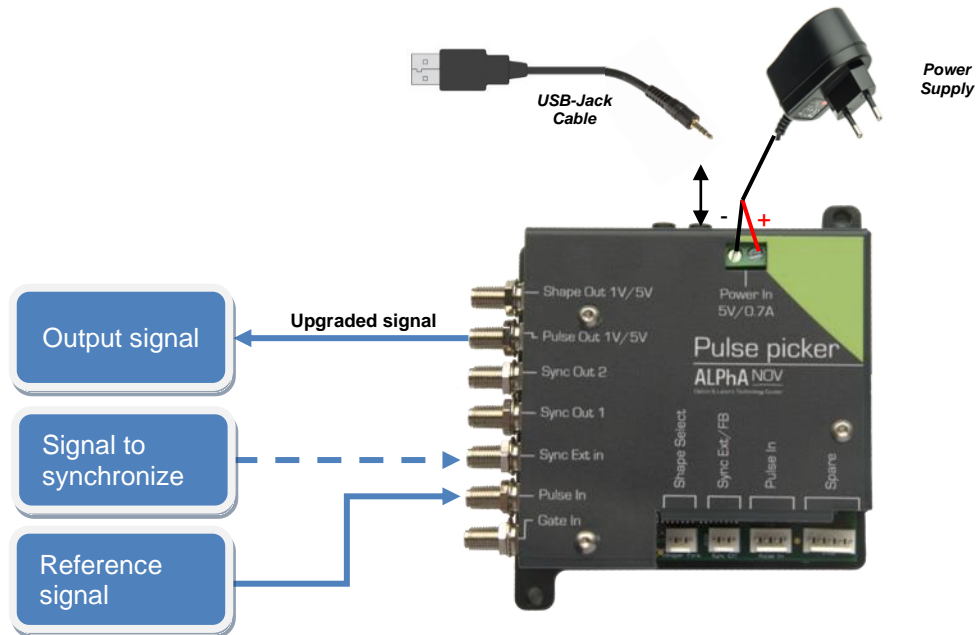

Figure 4 : Main firmware features used in synchronization mode

3. Cabling

5. Plug the USB-Jack cable in the "USB In" connector
6. Plug the signal to synchronize in the "Sync Ext in" SMA connector. (only for external signal synchronization). If signal to synchronize is internally generated, no signal needed on "Sync Ext in".

7. Plug the reference signal (i.e. the signal on which “Sync Ext In” signal or “internal signal” will be synchronized with) in the “*Pulse In*” SMA connector
8. The synchronized signal will output on the “*Pulse Out*” SMA connector
9. Finally, plug the power supply to the “*Power In*” connector to power on the board



4. Software configuration

Launch the ALPhANOV Control Software and click on *Connect* to start the TOMBAK hardware detection. The software automatically detects the TOMBAK board.

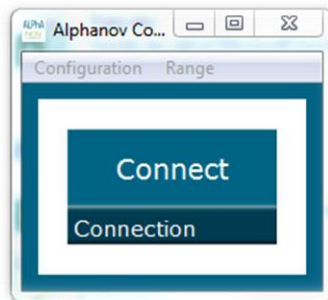

A window will appear for each TOMBAK connected to the computer.

The main configuration windows must be configured as follow :

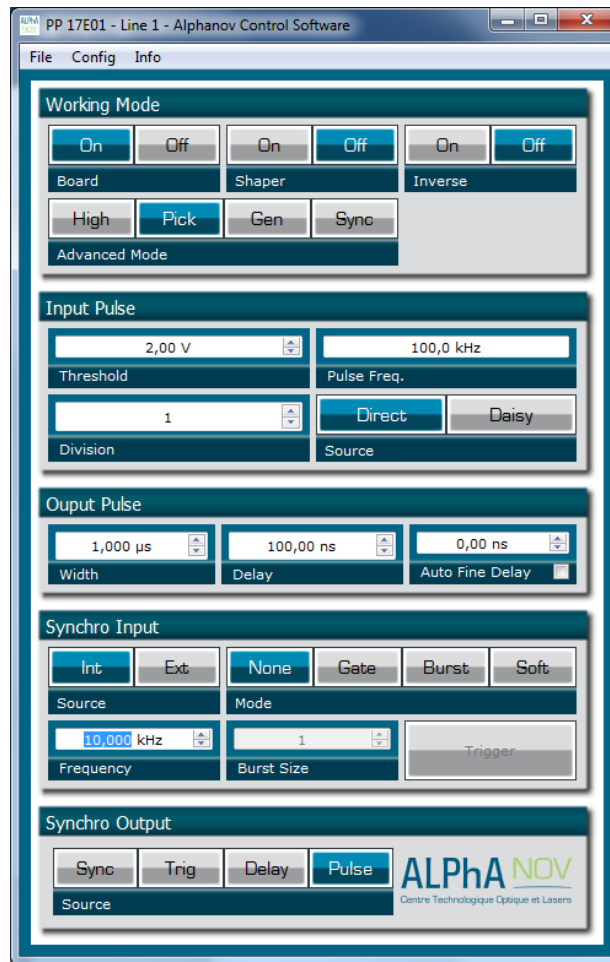

- Working Mode window :
 - Set the **Board** On
 - Set the **Shaper** button to **Off**
 - Set the **Inverse** button to **Off** unless you need to invert the output signal
 - Set **Advanced Mode** to **Pick**

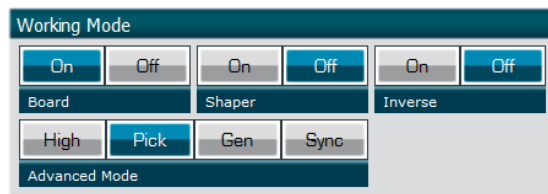

- Input pulse window :

- Configure the **Threshold** voltage so that the input **pulse frequency** is detected and the same as your pulse generator system
- Set the **Division** factor to **1**
- Set the input pulse **Source** to **Direct**

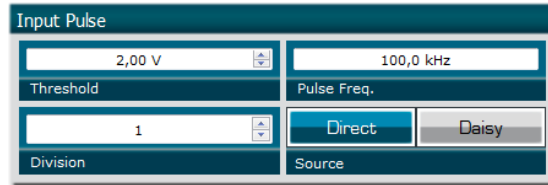

- Output Pulse window :
 - Choose the output **delay value**
 - Choose the output **pulse width**
 - **Auto Fine Delay** may be let in auto mode

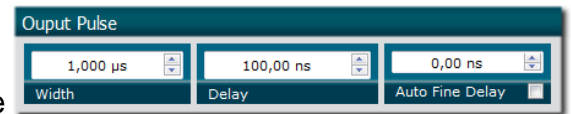

- Synchro input windows :
 - Source :
 - ⇒ Set **Int** to synchronize an internal generated signal with Pulse-In signal.
 - ⇒ Set **Ext** to synchronize an external signal (connected to Ext-In connector) with Pulse-In signal.
 - Mode : None
 - Frequency :
 - ⇒ If internal source is selected, set the output signal **Frequency** you need to synchronize.
 - ⇒ If external source is selected, **Frequency** shows the input Ext-In signal frequency
 - Burst size : not used in this mode

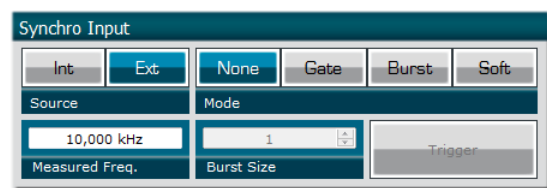
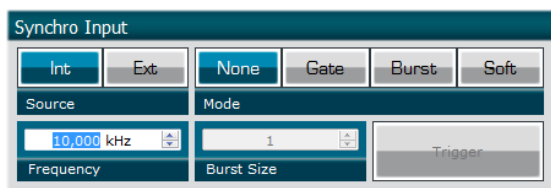

- Synchro output window (default settings) :
 - Source : Pulse



Don't forget to save the settings by clicking on the "Save" button in the bar menu.

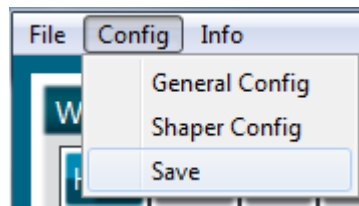

5. Main features

Adjustable pulse width <ul style="list-style-type: none">▪ resolution (for pulse width [5ns – 510ns])▪ resolution (for pulse width [511ns – 2⁶²ns])	[5ns – >>1000s] 2ns 5ns
Adjustable pulse delay <ul style="list-style-type: none">▪ resolution	[70ns – >>1000s] 10ps
Input Ext-In Voltage <ul style="list-style-type: none">▪ Logic Low▪ Logic High	[0-0.8V] [1.7-3.3V]
Input PulseIn voltage	30 mV – 3,3V
Input maximum frequency	200 MHz
Output Voltage	1 / 3,3 / 5 Volts (hardware setup)
Output maximum frequency	20 MHz

Mode 3 : Pulse Picking with Burst Shaping

1. Timing diagrams

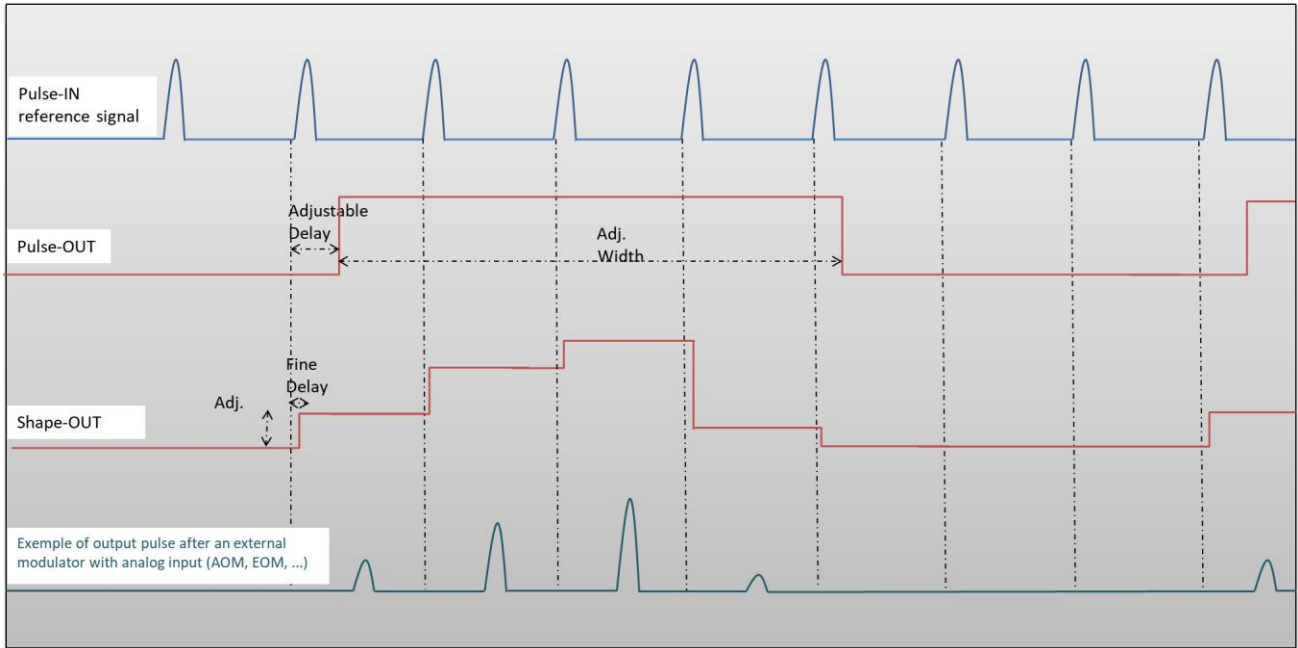

Figure 5 : Analog (Shape-OUT) and digital (Pulse-OUT) outputs with amplitude, delay and pulse width adjusted signals from input

2. Synoptic

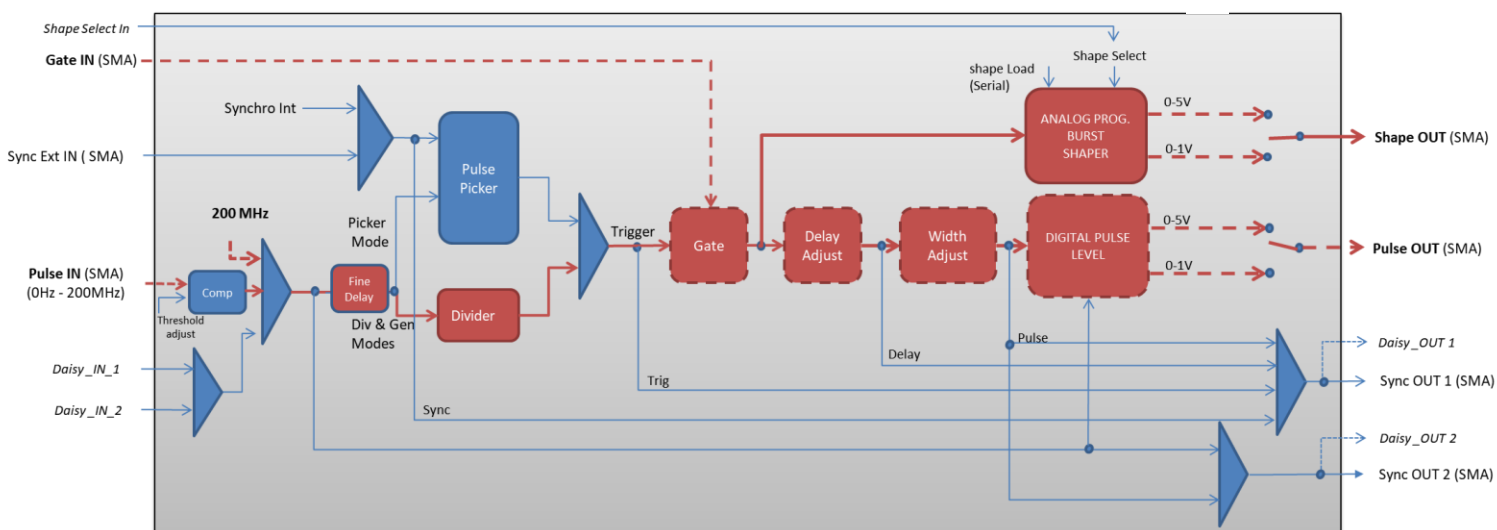
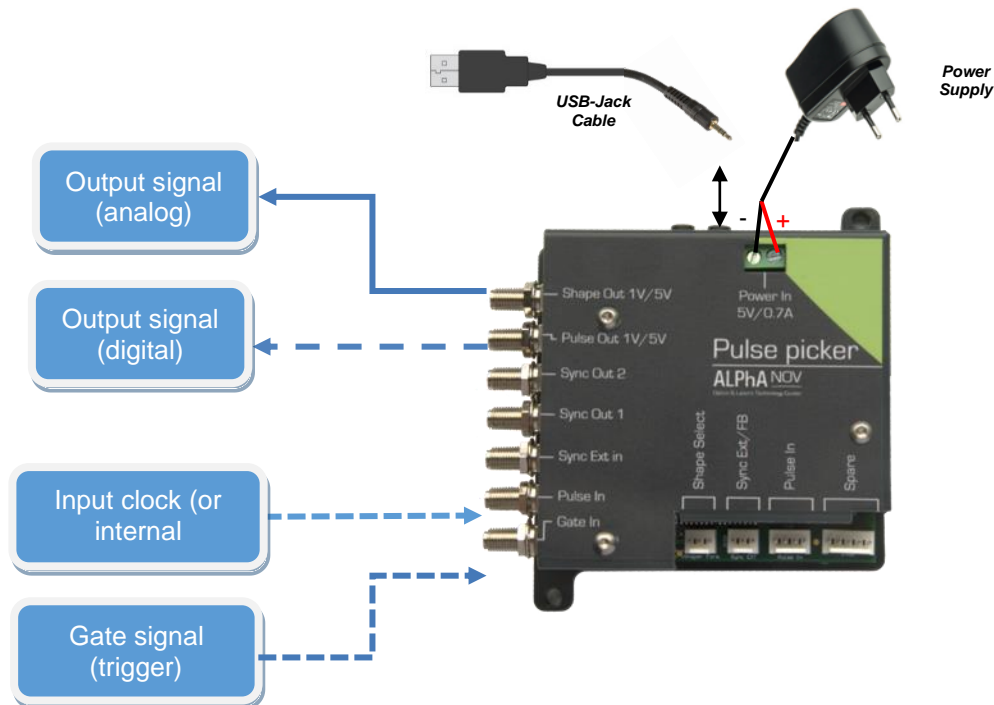

Figure 6 : Main firmware features used in AWG / Burst shaper mode (dashed lines are optional)

3. Cabling

The steps given below in () are optional and link to previous configuration described in § Erreur ! Source du renvoi introuvable. **p.** Erreur ! Signet non défini. (Gate feature), in § Erreur ! Source du renvoi introuvable. **p.** Erreur ! Signet non défini. (Burst generator using the Gate input), and in § Erreur ! Source du renvoi introuvable. **p.** Erreur ! Signet non défini. (Frequency divider).

1. Plug the USB-Jack cable in the “*USB In*” connector
2. (Plug your reference signal (clock) in the “*Pulse In*” SMA connector)
3. (Plug your trigger/gate signal in the “*Gate In*” SMA connector)
4. The signal will output on the “*Shape Out*” SMA connector
5. Finally, plug the power supply to the “*Power In*” connector to power on the board



4. Software configuration

Launch the ALPhANOV Control Software and click on *Connect* to start the Tombak hardware detection. The software automatically detects the Tombak board.

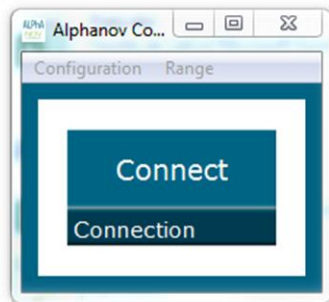

A window will appear for each Tombak connected to the computer.
 The main configuration windows must be configured as follow :

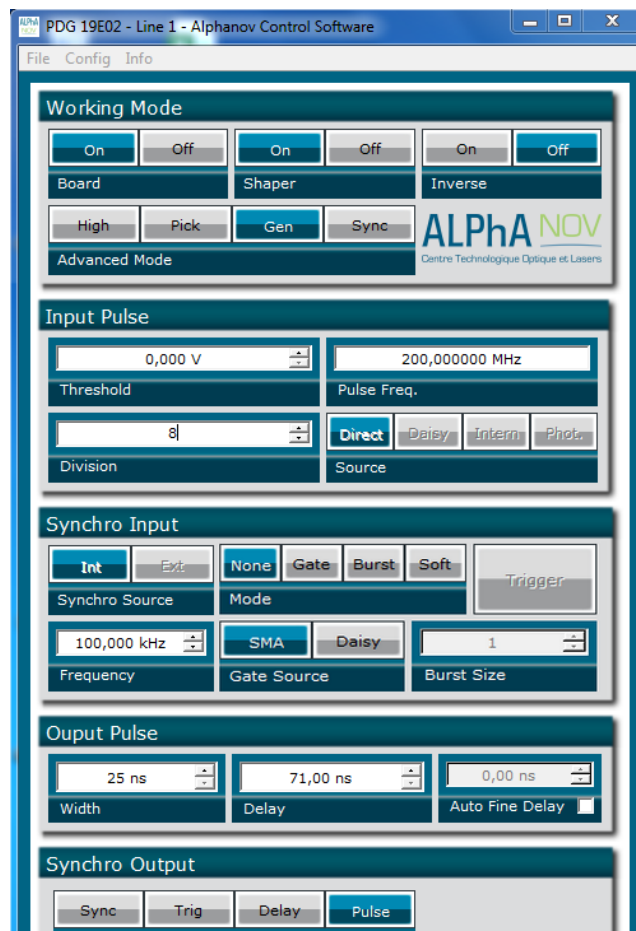

- Working Mode window :
 - Set the **Board** On
 - Set the **Shaper** button to **On**
 - Set the **Inverse** button to **Off** unless you need to invert the output signal
 - Set **Advanced Mode** to **Nothing** (use external clock) or **Gen** (use 200MHz internal frequency)

- Input pulse window :
 - (Configure the **Threshold** voltage so that the input **pulse frequency** is detected and equal to your pulse generator system)
 - Set the **Division** factor **according to your application**

- Set the input pulse **Source** to **Direct**
- Output Pulse window :
 - Choose the output **delay value**
 - Choose the output **pulse width**
 - **Auto Fine Delay** may be let in auto mode or manual if you need to adjust the fine delay from reference signal to each shape point (see Figure 5).
- Configure shape :
 - Open the **shaper config** window by clicking on the “Shaper Config” in the bar menu

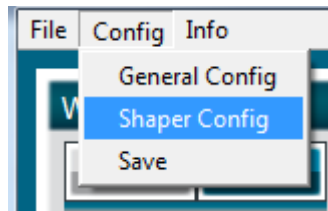

- The following window will appear. **Load a .csv file** by clicking on Load
-

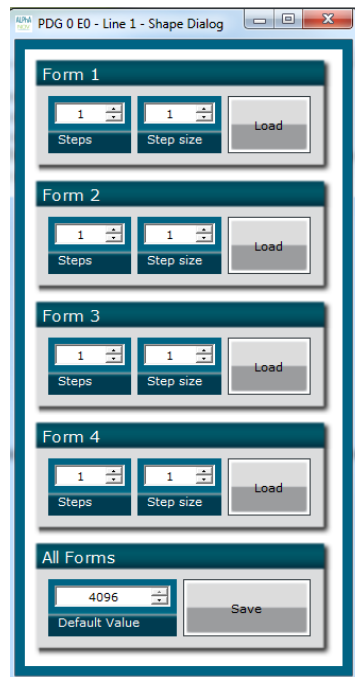

- The **.csv file** should be like this (example and explanation) :

```

1 4
2 1000
3 3000
4 4095
5 500
6 0
7

```

```

1 Number of points - 1
2 Value in bit for 1st point (from 0 to 4095)
3 Value in bit for 2nd point (from 0 to 4095)
4 Value in bit for 3rd point (from 0 to 4095)
5 Value in bit for 4th point (from 0 to 4095)
6 ...
7

```

Please note that repetitive values of 0 could be used to make non-uniform period between pulses.

The maximum number of points is 4000.

- The **number of points, called steps**, should be automatically detected after uploaded the file
- The step size should be leave to 1 or could be higher if you want to change the point after several reference pulses (for example a step size of 2 will change the level one time for two pulses)

Don't forget to save the settings by clicking on the "Save" button in the bar menu.

