

830 nm laser diode

600 mW / 105 μm fiber / FC-PC connector

VBG (Volume Bragg Grating) wavelength locking technology



Reference: 830LD-2-0-0

SPECIFICATIONS	Unit	Min	Typ	Maximum
Output Power	mW	600		
Center Wavelength	nm	830±0.5		
Spectral Width (FWHM)	nm	<0.1		
Threshold Current	A		0.4	
Operating Current	A		1.1	1.5
Operation Voltage	V		1.9	2.2
Conversion Efficiency	%		50	
Wavelength shift w Temperature	nm/°C		0.01	
Slope Efficiency	W/A		1.0	
Storage Temperature	°C	-20		70
Case Operating Temperature	°C	20		30
Minimum Fiber Bend Radius	mm	30		
Fiber Buffer/tube Diameter	μm		900	
Fiber Clad Diameter	μm		125	
Fiber Core Diameter	μm		105	
Numerical Aperture	NA		0.22	
Soldering Temperature	°C			260
Soldering time	s			10
Dimensions	mm	14 pin Butterfly module - 30*12.7*8.1		
Mounting holes diameter/distance	mm	4*Ø2.1 / 26 * 9		
Fiber connector		Yes (FC/PC)		
ROHS Compliant		Yes		

Form factor:

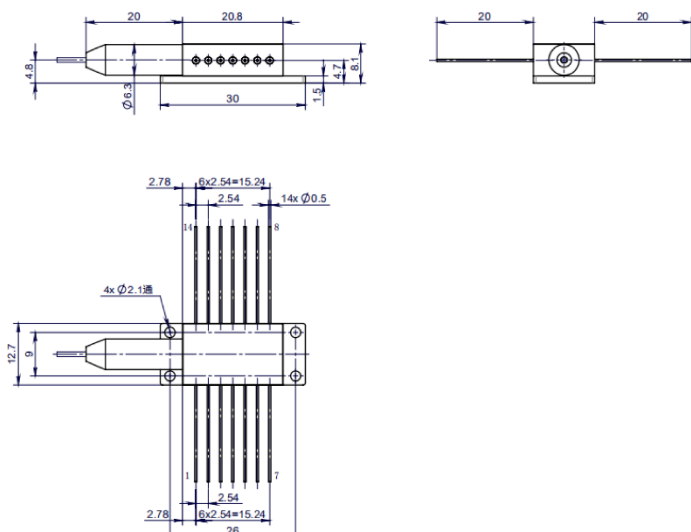

Laser diode pinning:

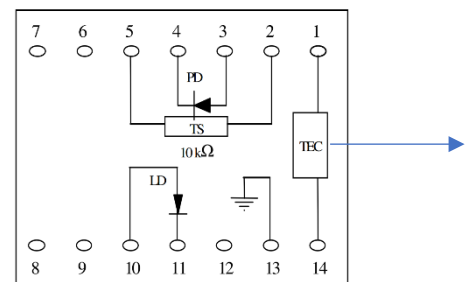

Totally floating pin-out