

Free-space AOM (Acousto-Optic Modulator)

High speed 200 MHz version – 632 nm

Reference: 635FSAOM-200-0.3

Technology/Crystal: TeO₂*

SPECIFICATIONS	Unit	Min	Typ.	Max	Comments
AOM Material			TeO ₂		
Wavelength	nm	550	632	680	Customizable
RF Frequency	MHz		200		
Active Aperture	mm		0.3		
Input impedance	Ω		50		
Frequency shift	MHz		200		
RF Power	W		1.0		
Max Optical Input CW/average Power	W			15	
Max Optical Power/surface	MW/cm ²			50	
Efficiency (optimized beam conditions)	%	85	88		
Rise/fall time (beam 150 μm)	ns		24		
Rise/fall time (beam 60 μm)	ns		10		
Crystal coating transmittance (per surface)	%	99.5			
Electrical input interface			SMA		
Working temperature	°C	-20		60	
Storage temperature	°C	-30		70	
Dimensions	mm ³	41.8*25*13.5			
Mounting holes diameter	mm		2*M2		
Diffraction Angle = $\lambda \cdot f / V$ (with : λ : wavelength (in nm) ; f : RF frequency (in MHz) ; V=4200)	mrad		30.1		

*: See our tutorial: [fiber modulator](#)

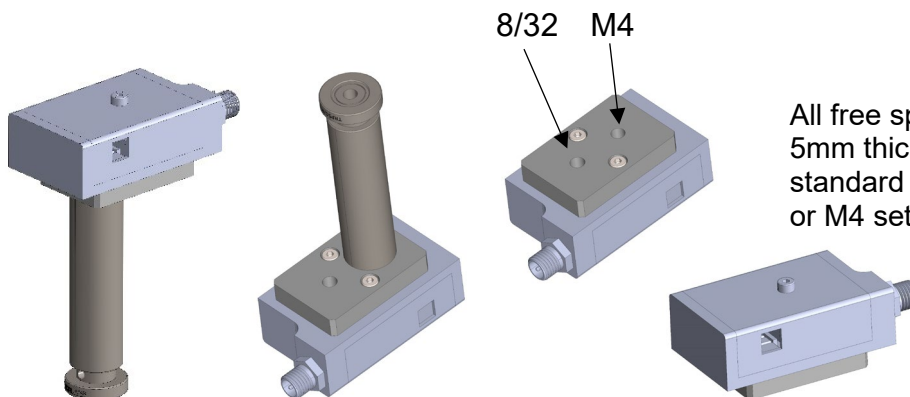
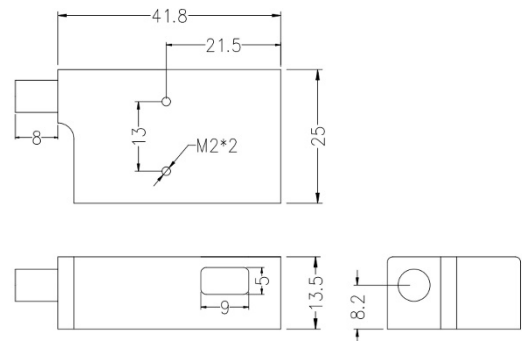

All free space AOMs are supplied with a 5mm thick adapter plate compatible with standard pedestal bases with either 8/32 or M4 setscrews.